

Product Summary

Part #	V_{CE}	I_C	$V_{CEsat}, T_{vj}=25^{\circ}C$
DP40N65KBE3	650V	40A	1.5V

Features

- Uses advanced FS IGBT technology
- Excellent conduction and switching loss
- Excellent stability and uniformity
- Fast and soft antiparallel diode

Applications

- Induction converters
- Uninterruptible power supplies
- Home Appliances

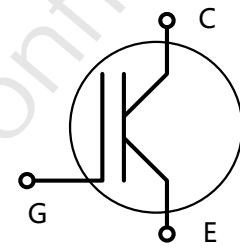
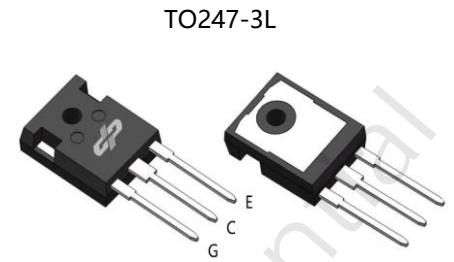
Package Marking and Ordering Information

Part #	Marking	Package	Packing
DP40N65KBE3	40N65KBE3	TO247-3L	Tube

Absolute Maximum Ratings

Parameter	Symbol	Value	Unit
Collector-Emitter voltage	V_{CE}	650	V
Continuous collector current	I_C	80	A
$T_C = 25^{\circ}C$		40	
$T_C = 100^{\circ}C$			
Pulsed collector current ($T_C = 25^{\circ}C$, t_p limited by T_{jmax})	$I_{D\ pulse}$	120	A
Turn off safe operating area $V_{CE} \leq 650V$, $T_{vj} \leq 175^{\circ}C$	-	120	A
Gate-emitter voltage	V_{GE}	± 30	V
Power dissipation ($T_C = 25^{\circ}C$)	P_{tot}	300	W
Operating junction temperature	T_j, T_{stg}	-40...+175	$^{\circ}C$
Storage temperature	T_j, T_{stg}	-55...+150	$^{\circ}C$

Thermal Resistance

Parameter	Symbol	Max	Unit
IGBT thermal resistance, junction case. Max	R_{thJC}	0.50	$^{\circ}C/W$
Thermal resistance, junction – ambient. Max	R_{thJA}	40	

Electrical Characteristic (at $T_j = 25^\circ\text{C}$, unless otherwise specified)

Parameter	Symbol	Value			Unit	Test Condition
		min.	typ.	max.		
Collector-emitter breakdown voltage	$V_{(BR)CES}$	650	-	-	V	$V_{GE}=0V, I_C=250\mu A$
Collector-emitter saturation voltage	V_{CEsat}	-	1.5	1.85	V	$V_{GE} = 15V, I_C = 40A$ $T_{vj}=25^\circ\text{C}$
		-	1.85	-		$T_{vj}=150^\circ\text{C}$
Gate-emitter threshold voltage	$V_{GE(th)}$	3.5	4.5	5.5	V	$V_{GE} = V_{CE}, I_C = 1mA$
Zero gate voltage collector current	I_{CES}	-	-	1	μA	$V_{CE}=650V, V_{GS}=0V$ $T_{vj}=25^\circ\text{C}$
		-	100	-		$T_{vj}=150^\circ\text{C}$
Gate-emitter leakage current	I_{GES}	-	-	100	nA	$V_{CE} = 0V, V_{GE} = 20V$
Transconductance	g_{fs}	-	14	-	S	$V_{CE} = 20V, I_{CE} = 40A$

Dynamic Characteristic

Input Capacitance	C_{ies}	-	3413	-	pF	$V_{CE} = 25V, V_{GE} = 0V,$ $f = 1MHz$
Output Capacitance	C_{oes}	-	67	-		
Reverse Transfer Capacitance	C_{res}	-	28	-		
Gate Total Charge	Q_g	-	112	-	nC	$V_{CC} = 520V, I_C = 40A,$ $V_{GE} = 15V$
Gate-Source charge	Q_{ge}	-	35	-		
Gate-Drain charge	Q_{gc}	-	30	-		
Turn-on delay time	$t_{d(on)}$	-	26	-	ns	$T_{vj} = 25^\circ\text{C},$ $V_{CC}=400V, I_C=40A,$ $V_{GE}=15.0V,$ $R_G=10.0\Omega$
Rise time	t_r	-	52	-		
Turn-off delay time	$t_{d(off)}$	-	120	-		
Fall time	t_f	-	67	-		
Turn-on energy	E_{on}	-	0.72	-	mJ	
Turn-off energy	E_{off}	-	0.80	-		

Typical Performance Characteristics

Fig 1: Output Characteristics

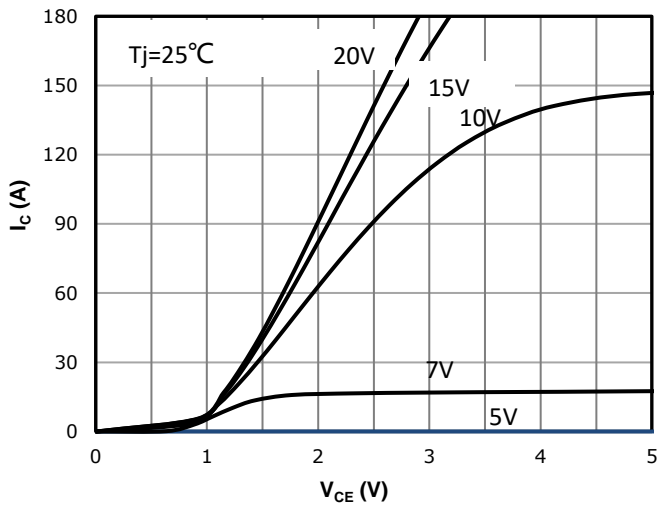

Fig 2: Output Characteristics

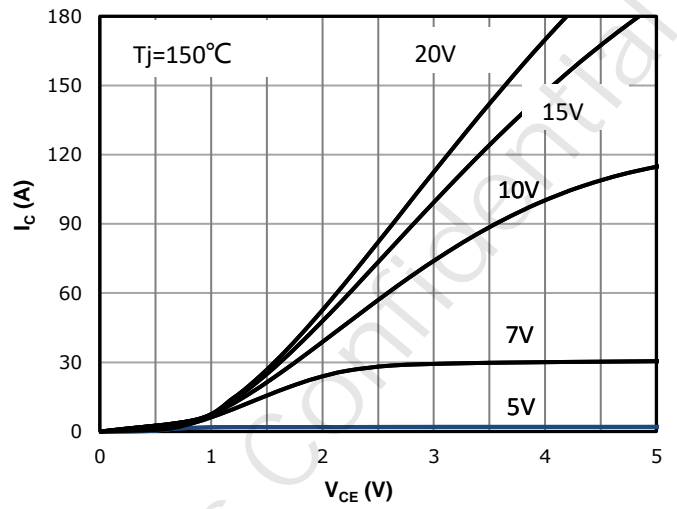

Fig 3: Transfer Characteristics

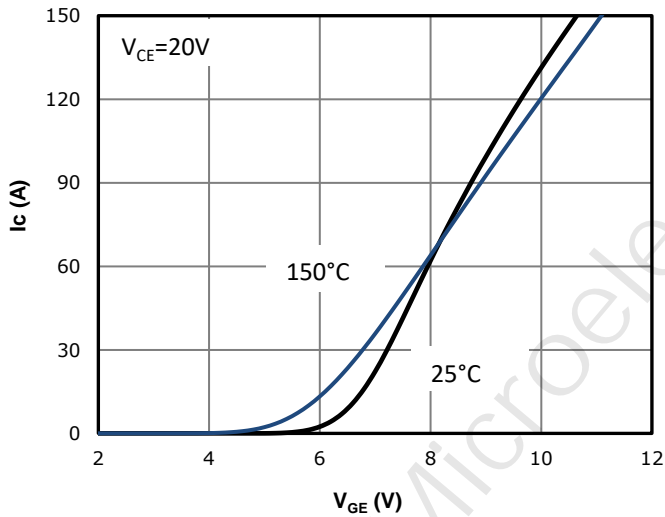

Fig 4: Typical collector-emitter voltage

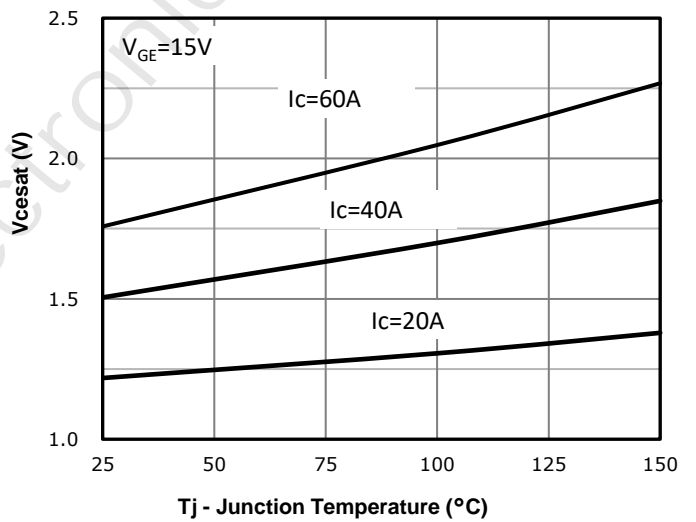

Fig 5: Gate Charge Characteristics

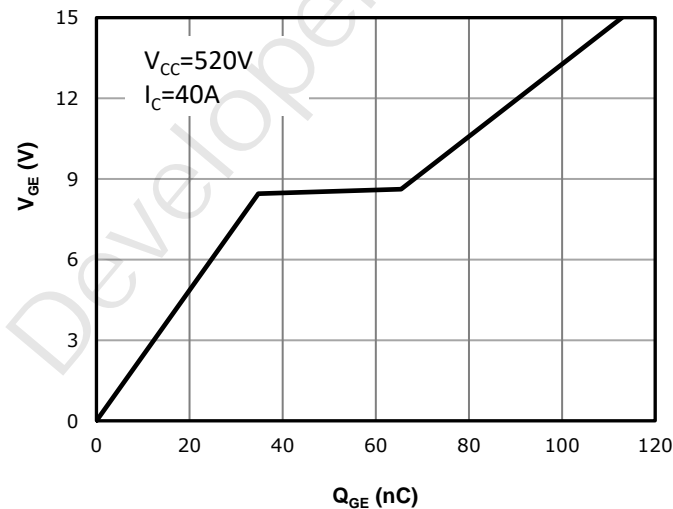

Fig 6: Capacitance Characteristics

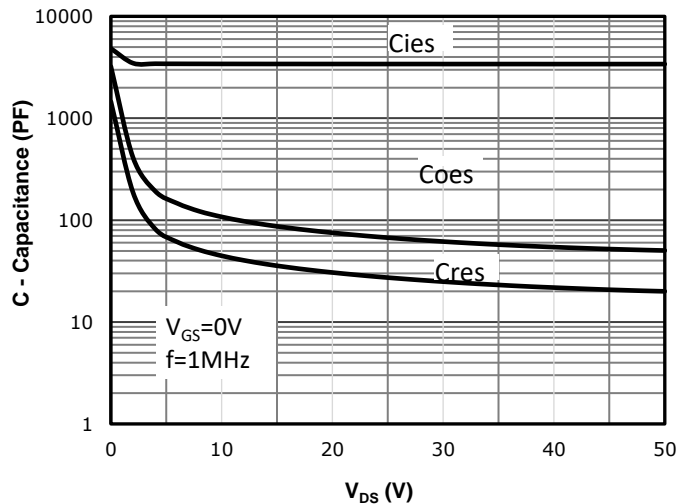

Fig 7: Typical switching energy losses

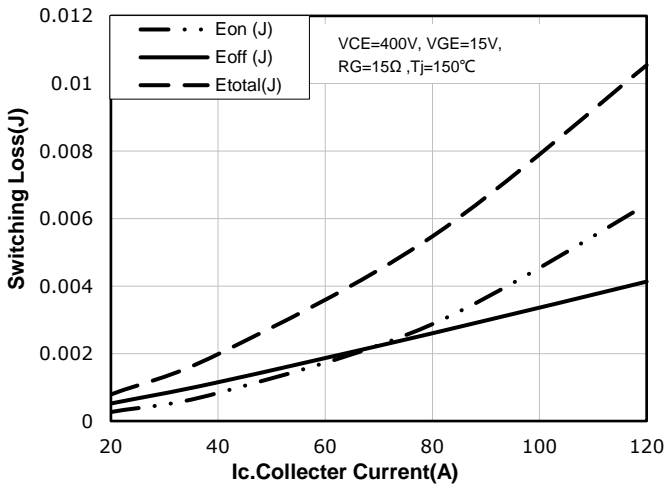

Fig 8: Typical switching times as a function of gate resistor

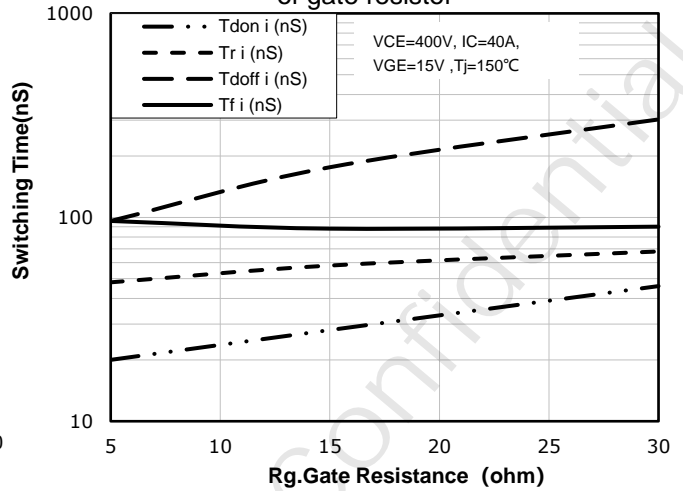

Fig 9: Typical switching energy losses as a function of gate resistor

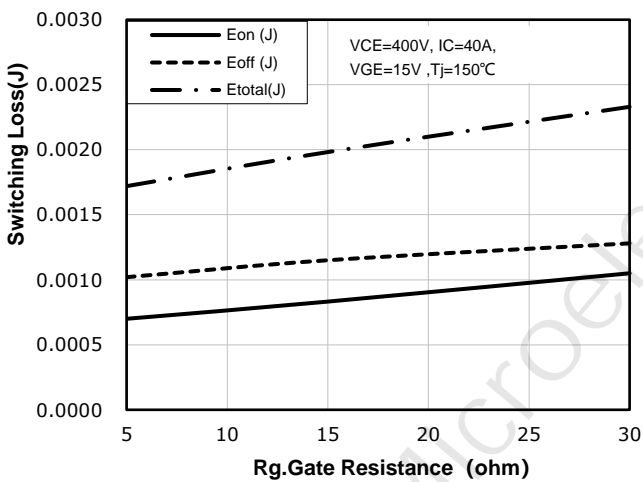

Fig 10: Typical switching energy losses as a function of collector emitter voltage

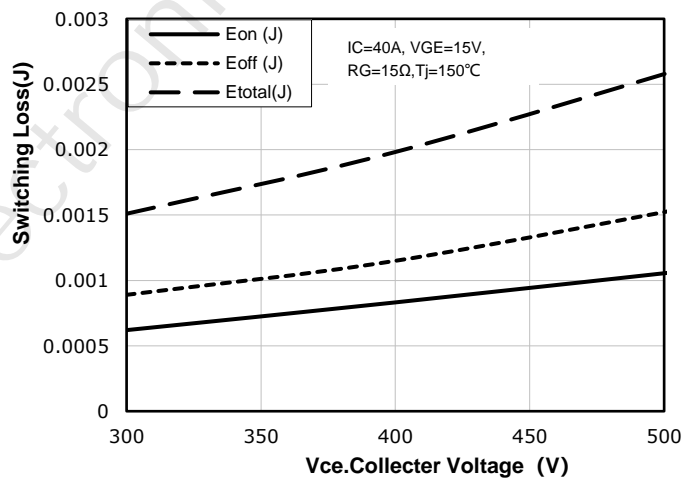

Fig 11: Typical switching times as a function of junction temperature

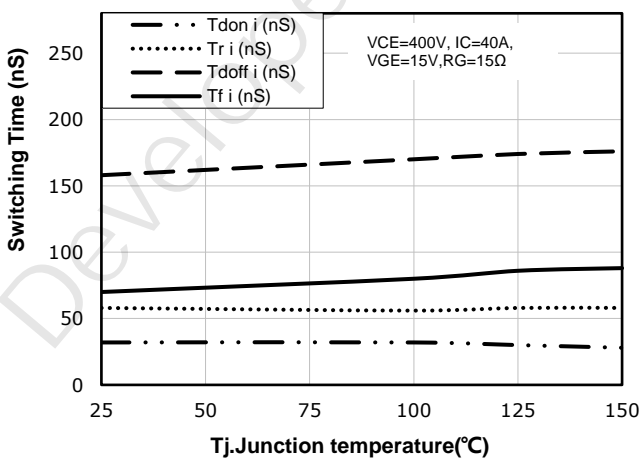

Fig 12: Typical switching energy losses as a function of junction temperature

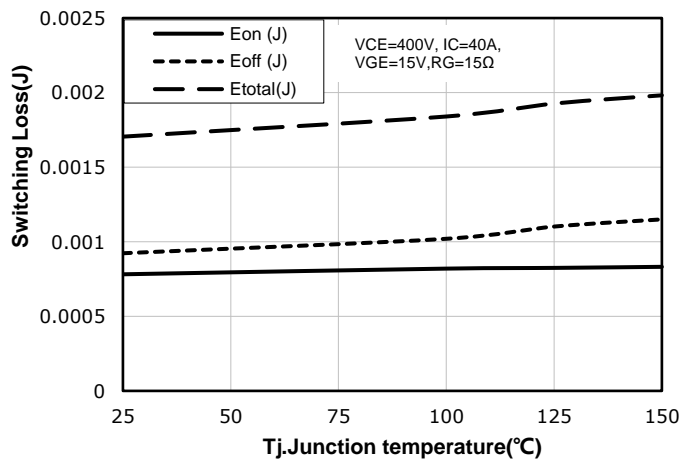
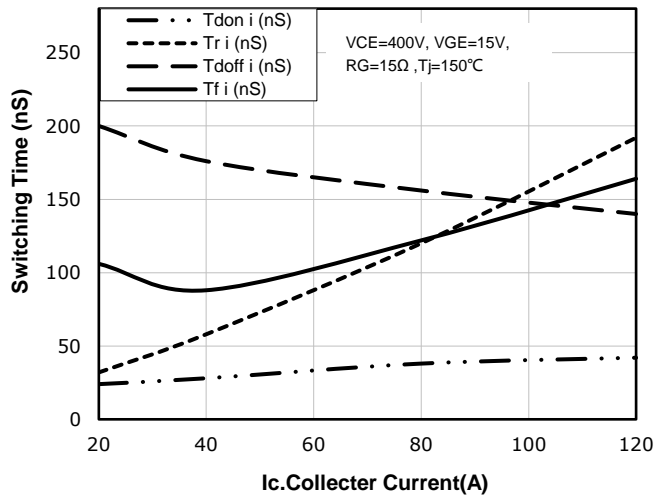
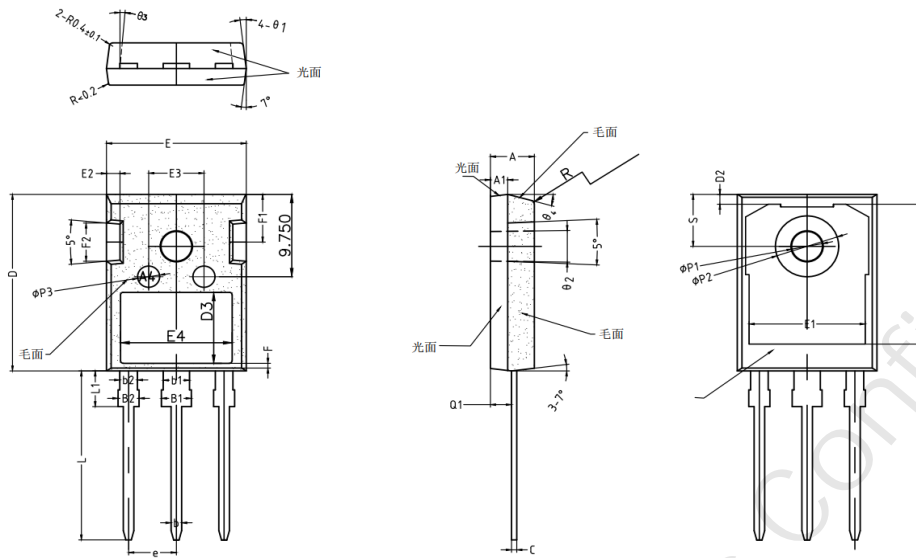

Fig 13: Typical switching times



Developer Microelectronics Confidential

Package Outline: TO247-3L

Symbol	Dimensions In Millimeters		
	MIN	NOM	MAX
A	4.90	5.00	5.10
A1	1.90	2.00	2.10
b	1.15	1.20	1.25
b1	2.95	3.00	3.05
b2	1.95	2.00	2.05
B1	3.00	3.10	3.20
B2	1.90	2.00	2.10
c	0.55	0.60	0.65
D	20.90	21.00	21.10
D1	16.45	16.55	16.65
D2	1.07	1.17	1.27
D3	8.15	8.20	8.25
E	15.70	15.80	15.90
E1	13.16	13.26	13.36
E2	2.40	2.50	2.60
E3	6.10	6.20	6.30
E4	12.70	12.80	12.90
F	0.75	0.85	0.95
F1	5.70	5.80	5.90
F2	4.90	5.00	5.10
F3	9.90	10.00	10.10
e	5.44 BSC		
L	19.72	19.92	20.12
L1	4.03	4.13	4.23
θ1	5°	7°	9°
θ2	1°	2°	3°
θ3	4°	5°	6°
θ4	13°	15°	17°
ΦP1	3.50	3.60	3.70
ΦP2	7.09	7.19	7.29
ΦP3	2.40	2.50	2.60
Q1	2.31	2.41	2.51
S	6.05	6.15	6.25
R	0.30	0.40	0.50

Part Marking Information

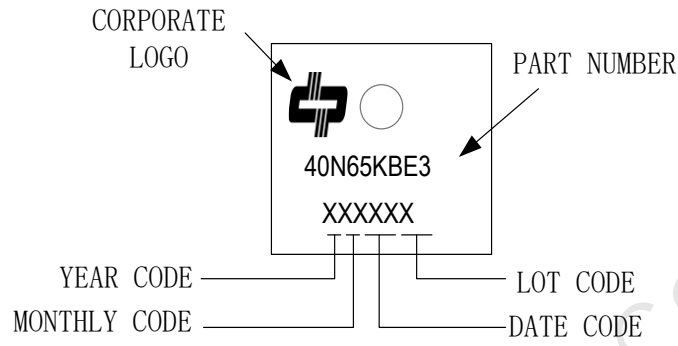

Developer Microelectronics Confidential

Revision History

Revision	Major changes
1.0	Release for initial version1.0

重要声明 Important Notice

德普微尽力确保本产品规格书内容的准确和可靠，但是保留在没有通知的情况下，修改规格书内容的权利。客户在下订单前应联系德普微获取最新的相关信息，并验证这些信息是否完整且是最新的。所有产品的销售都遵循在订单确认时所提供的本公司销售条款与条件。

德普微会不定期更新本文档内容，产品实际参数可能因型号或者其他事项不同有所差异，本文档不作为任何明示或暗示的担保或授权。

本产品规格书未包含任何针对德普微或第三方所有的知识产权的授权。针对本产品规格书所记载的信息，德普微不做任何明示或暗示的保证，包括但不限于对规格书内容的准确性、商业上的适销性，特定目的适用性或者不侵犯德普微或任何第三人知识产权做任何明示或暗示保证，德普微也不就因本规格书本身及其使用有关的偶然或必然损失承担任何责任。

德普微对应用帮助或客户产品设计不承担任何义务。客户应对其使用本公司的产品和应用自行负责。为尽量减小与客户产品和应用相关的风险，客户应提供充分的设计与操作安全验证。

针对本规格书所披露的内容，在未获得德普微的授权下，任何第三方不得使用、复制、转换，一经发现本公司必依法追究其法律责任，并赔偿由此对本公司造成的一切损失。

请注意在本资料记载的条件范围内使用产品，特别请注意绝对最大额定值、工作电压范围和电气特性等。因在本资料记载的条件范围外使用产品而造成的故障和(或)事故等的损害，本公司对此概不承担任何责任。

本公司一直致力于提高产品的质量和可靠度，但所有的半导体产品都有一定的失效概率，这些失效概率可能会导致一些人身事故、火灾事故等。当设计产品时，请充分留意冗余设计并采用安全指标，这样可以避免事故的发生。

使用本公司的IC生产产品时，如因其产品中对该IC的使用方法或产品的规格，或因进口国等原因，包含本IC产品在内的制品发生专利纠纷时，本公司概不承担相应责任。